

## Full - Bridge Super Junction MOSFET Power Module

$V_{DSS} = 800V$   
 $R_{DSon} = 150m\Omega \text{ max @ } T_j = 25^\circ C$   
 $I_D = 28A \text{ @ } T_c = 25^\circ C$

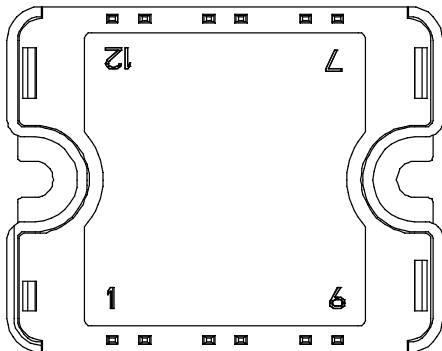
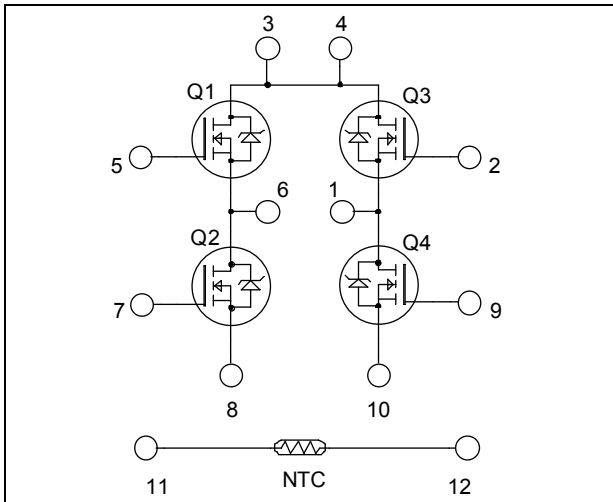

Pins 3/4 must be shorted together

### Application

- Welding converters
- Switched Mode Power Supplies
- Uninterruptible Power Supplies
- Motor control

### Features

- **COOLMOS**  
Power Semiconductors
  - Ultra low  $R_{DSon}$
  - Low Miller capacitance
  - Ultra low gate charge
  - Avalanche energy rated
  - Very rugged
- Very low stray inductance
  - Symmetrical design
- Internal thermistor for temperature monitoring
- High level of integration

### Benefits

- Outstanding performance at high frequency operation
- Direct mounting to heatsink (isolated package)
- Low junction to case thermal resistance
- Solderable terminals both for power and signal for easy PCB mounting
- Low profile
- Each leg can be easily paralleled to achieve a phase leg of twice the current capability
- RoHS Compliant

### Absolute maximum ratings

Symbol	Parameter	Max ratings	Unit
$V_{DSS}$	Drain - Source Breakdown Voltage	800	V
$I_D$	Continuous Drain Current	$T_c = 25^\circ C$	28
		$T_c = 80^\circ C$	21
$I_{DM}$	Pulsed Drain current	110	
$V_{GS}$	Gate - Source Voltage	$\pm 30$	V
$R_{DSon}$	Drain - Source ON Resistance	150	$m\Omega$
$P_D$	Maximum Power Dissipation	$T_c = 25^\circ C$	277
$I_{AR}$	Avalanche current (repetitive and non repetitive)	17	A
$E_{AR}$	Repetitive Avalanche Energy	0.5	mJ
$E_{AS}$	Single Pulse Avalanche Energy	670	

**CAUTION:** These Devices are sensitive to Electrostatic Discharge. Proper Handling Procedures Should Be Followed. See application note APT0502 on [www.microsemi.com](http://www.microsemi.com)

All ratings @  $T_j = 25^\circ\text{C}$  unless otherwise specified

**Electrical Characteristics**

Symbol	Characteristic	Test Conditions	Min	Typ	Max	Unit
$I_{DSS}$	Zero Gate Voltage Drain Current	$V_{GS} = 0V, V_{DS} = 800V$			50	$\mu\text{A}$
		$T_j = 25^\circ\text{C}$				
		$V_{GS} = 0V, V_{DS} = 800V$			375	
$R_{DS(on)}$	Drain – Source on Resistance	$V_{GS} = 10V, I_D = 14A$			150	$\text{m}\Omega$
$V_{GS(th)}$	Gate Threshold Voltage	$V_{GS} = V_{DS}, I_D = 2\text{mA}$	2.1	3	3.9	V
$I_{GSS}$	Gate – Source Leakage Current	$V_{GS} = \pm 20V, V_{DS} = 0V$			$\pm 150$	nA

**Dynamic Characteristics**

Symbol	Characteristic	Test Conditions	Min	Typ	Max	Unit
$C_{iss}$	Input Capacitance	$V_{GS} = 0V$		4507		pF
$C_{oss}$	Output Capacitance	$V_{DS} = 25V$		2092		
$C_{rss}$	Reverse Transfer Capacitance	$f = 1\text{MHz}$		108		
$Q_g$	Total gate Charge	$V_{GS} = 10V$ $V_{Bus} = 400V$ $I_D = 28A$		180		nC
$Q_{gs}$	Gate – Source Charge			22		
$Q_{gd}$	Gate – Drain Charge			90		
$T_{d(on)}$	Turn-on Delay Time	<b>Inductive switching @125°C</b> $V_{GS} = 15V$ $V_{Bus} = 533V$ $I_D = 28A$ $R_G = 2.5\Omega$		10		ns
$T_r$	Rise Time			13		
$T_{d(off)}$	Turn-off Delay Time			83		
$T_f$	Fall Time			35		
$E_{on}$	Turn-on Switching Energy	<b>Inductive switching @ 25°C</b> $V_{GS} = 15V, V_{Bus} = 533V$ $I_D = 28A, R_G = 2.5\Omega$		486		$\mu\text{J}$
$E_{off}$	Turn-off Switching Energy			278		
$E_{on}$	Turn-on Switching Energy	<b>Inductive switching @ 125°C</b> $V_{GS} = 15V, V_{Bus} = 533V$ $I_D = 28A, R_G = 2.5\Omega$		850		$\mu\text{J}$
$E_{off}$	Turn-off Switching Energy			342		

**Source - Drain diode ratings and characteristics**

Symbol	Characteristic	Test Conditions	Min	Typ	Max	Unit
$I_S$	Continuous Source current (Body diode)	$T_c = 25^\circ\text{C}$		28		A
		$T_c = 80^\circ\text{C}$		21		
$V_{SD}$	Diode Forward Voltage	$V_{GS} = 0V, I_S = -28A$			1.2	V
$dv/dt$	Peak Diode Recovery ❶				6	V/ns
$t_{rr}$	Reverse Recovery Time	$I_S = -28A$ $V_R = 400V$ $di_S/dt = 200A/\mu\text{s}$	$T_j = 25^\circ\text{C}$		550	ns
$Q_{rr}$	Reverse Recovery Charge		$T_j = 25^\circ\text{C}$		30	$\mu\text{C}$

 ❶  $dv/dt$  numbers reflect the limitations of the circuit rather than the device itself.

$$I_S \leq -28A \quad di/dt \leq 200A/\mu\text{s} \quad V_R \leq V_{DSS} \quad T_j \leq 150^\circ\text{C}$$

## Thermal and package characteristics

Symbol	Characteristic	Min	Typ	Max	Unit	
R <sub>thJC</sub>	Junction to Case Thermal Resistance			0.45	°C/W	
V <sub>ISOL</sub>	RMS Isolation Voltage, any terminal to case t=1 min, I <sub>isol</sub> <1mA, 50/60Hz	2500			V	
T <sub>J</sub>	Operating junction temperature range	-40		150	°C	
T <sub>STG</sub>	Storage Temperature Range	-40		125		
T <sub>C</sub>	Operating Case Temperature	-40		100		
Torque	Mounting torque	To heatsink	M4	2.5	4.7	N.m
Wt	Package Weight			80		g

## Temperature sensor NTC (see application note APT0406 on www.microsemi.com for more information).

Symbol	Characteristic	Min	Typ	Max	Unit
R <sub>25</sub>	Resistance @ 25°C		50		kΩ
B <sub>25/85</sub>	T <sub>25</sub> = 298.15 K		3952		K

$$R_T = \frac{R_{25}}{\exp \left[ B_{25/85} \left( \frac{1}{T_{25}} - \frac{1}{T} \right) \right]}$$

T: Thermistor temperature  
 R<sub>T</sub>: Thermistor value at T

## SP1 Package outline (dimensions in mm)

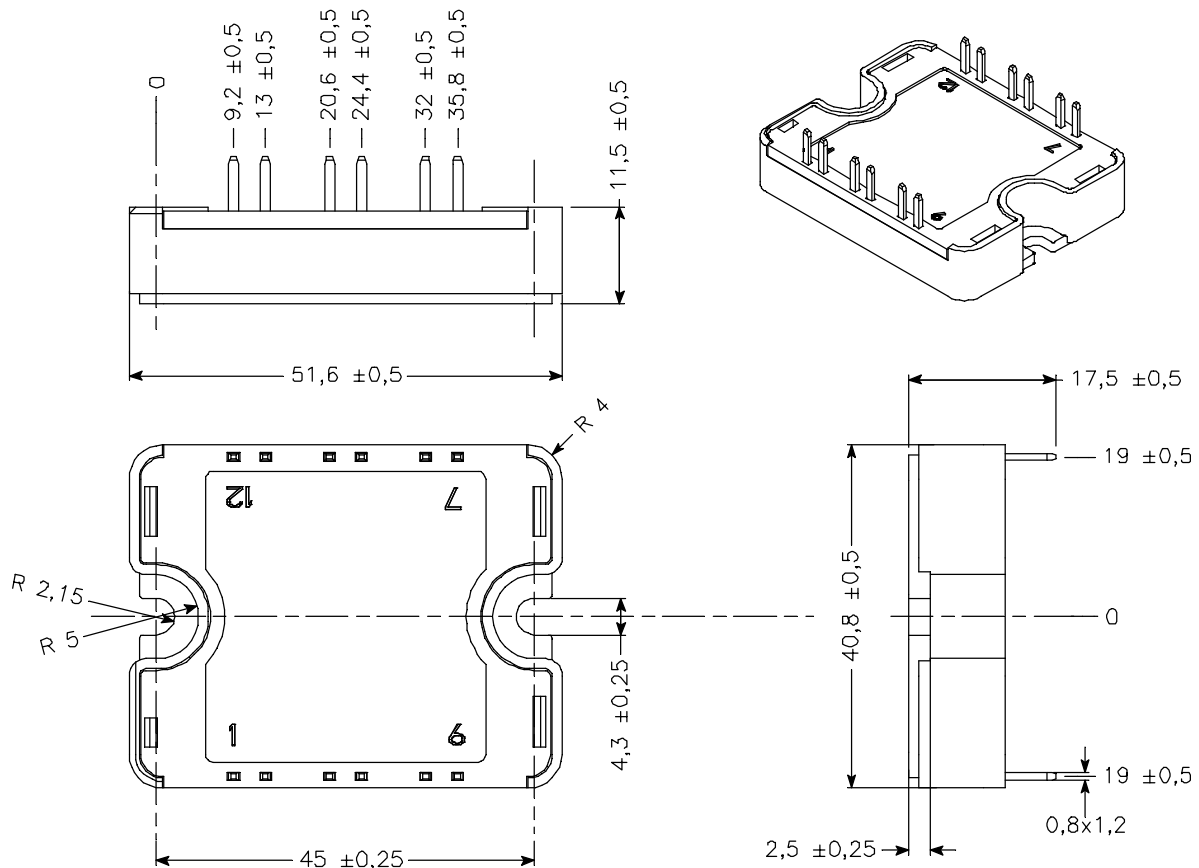

See application note 1904 - Mounting Instructions for SP1 Power Modules on www.microsemi.com

## Typical Performance Curve

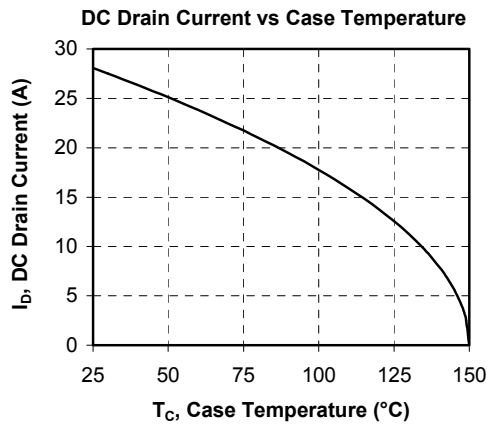
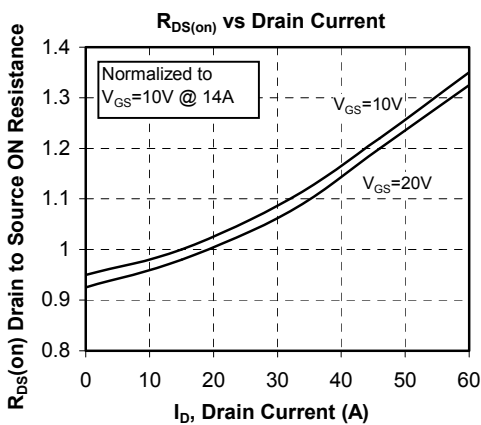
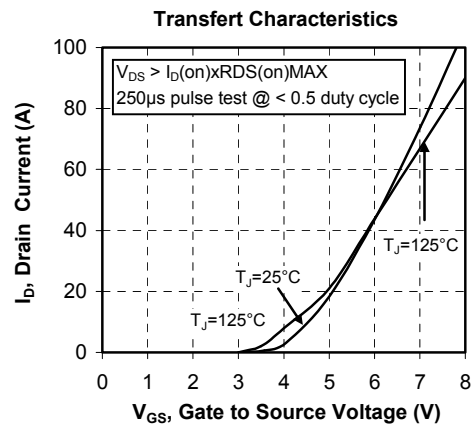
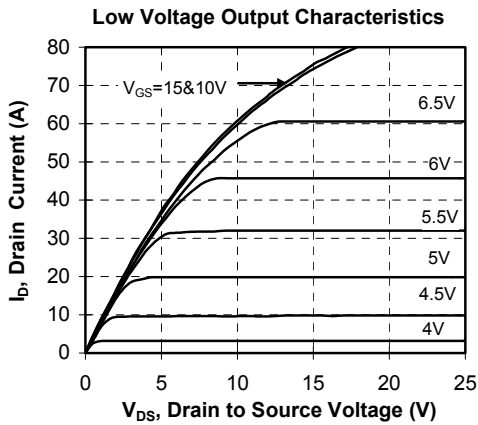
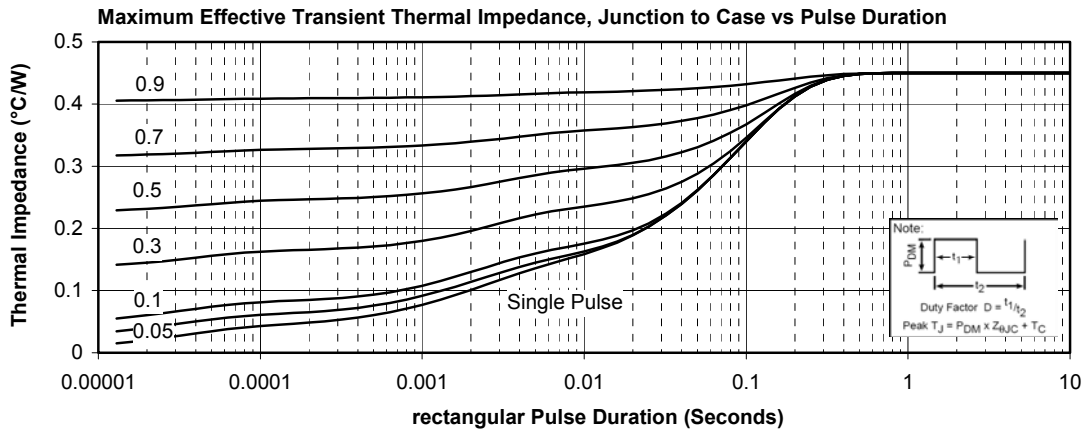

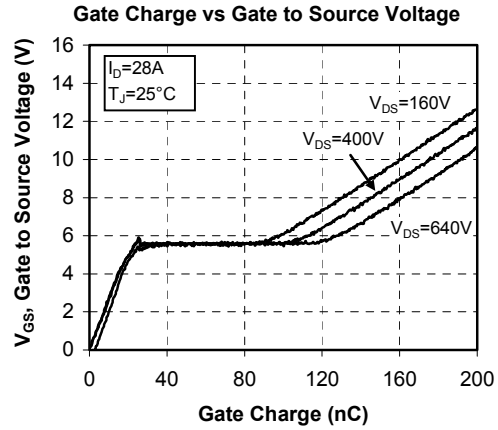
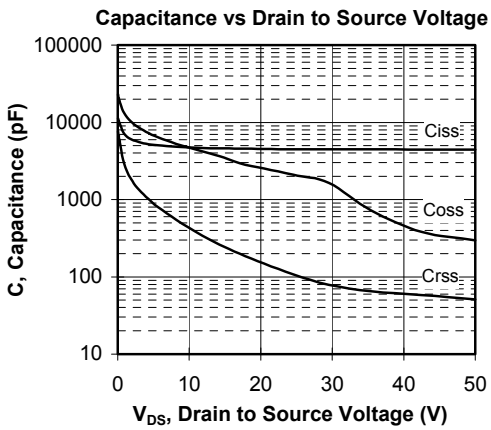
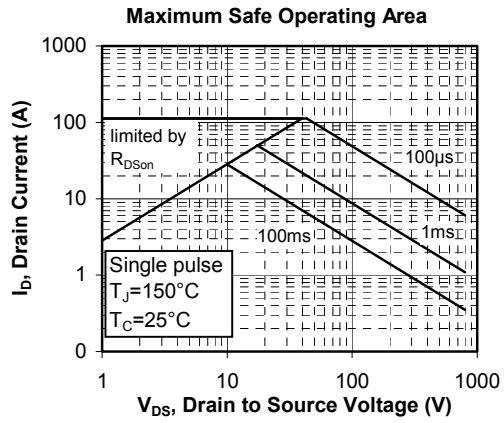
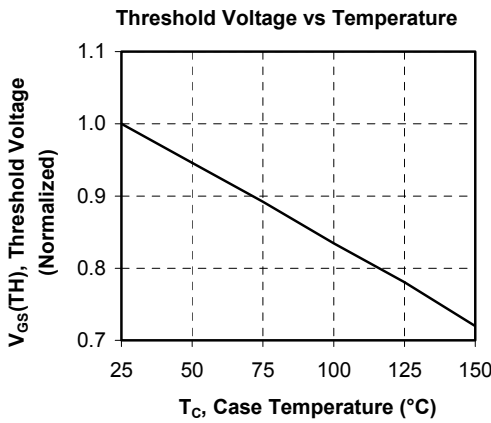
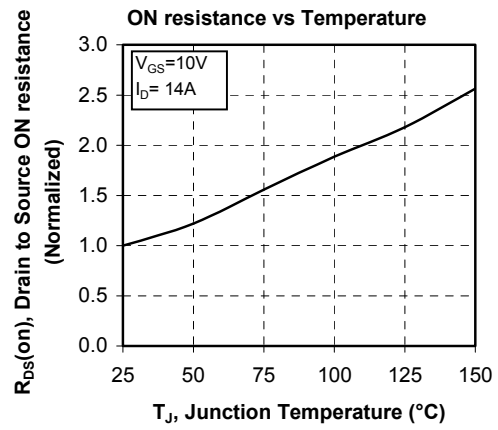
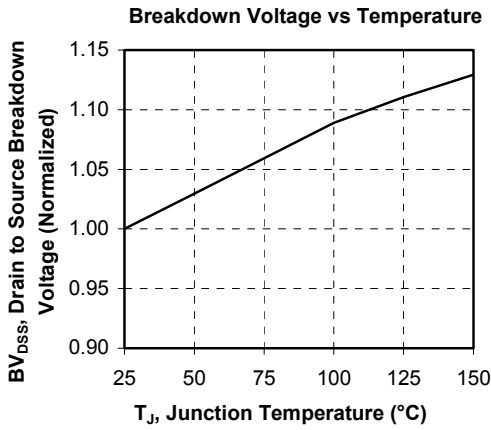

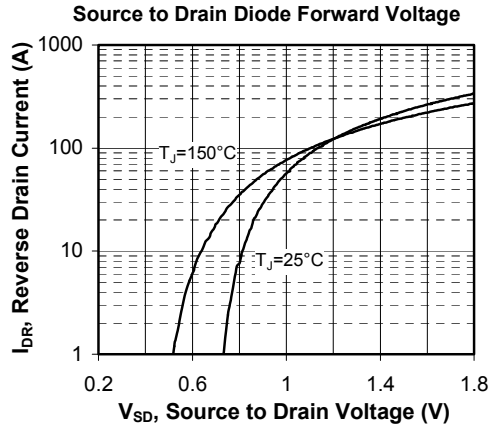
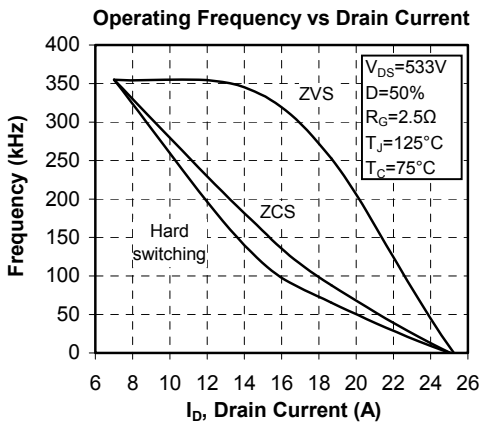
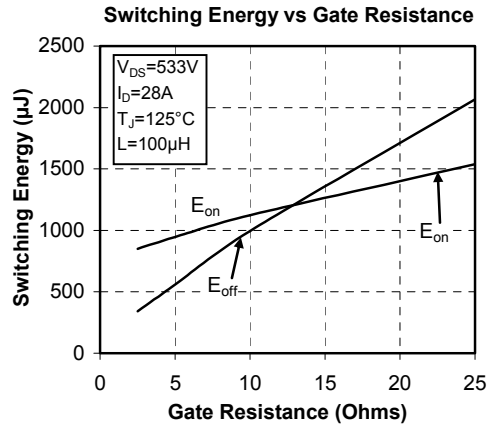
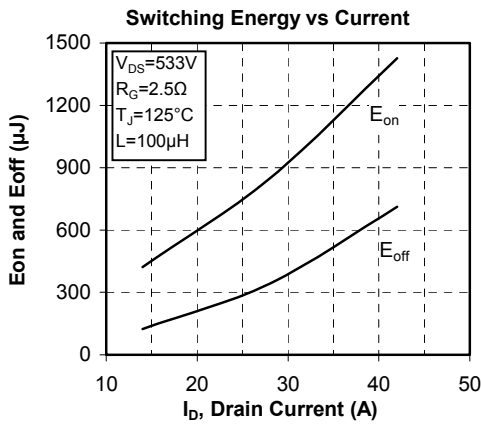
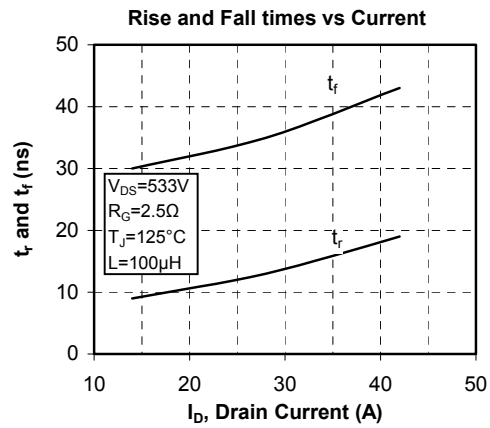
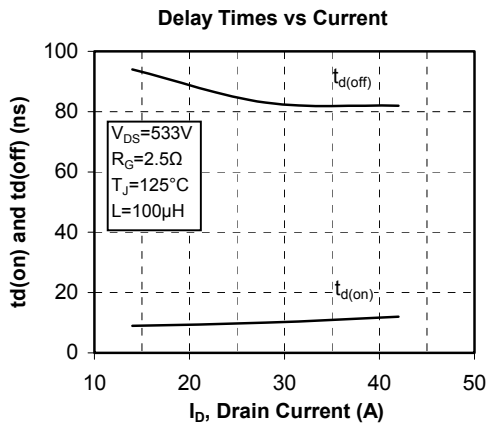

“COOLMOS™” comprise a new family of transistors developed by Infineon Technologies AG. “COOLMOS” is a trademark of Infineon Technologies AG”.

Microsemi reserves the right to change, without notice, the specifications and information contained herein

Microsemi's products are covered by one or more of U.S patents 4,895,810 5,045,903 5,089,434 5,182,234 5,019,522 5,262,336 6,503,786 5,256,583 4,748,103 5,283,202 5,231,474 5,434,095 5,528,058 and foreign patents. U.S and Foreign patents pending. All Rights Reserved.